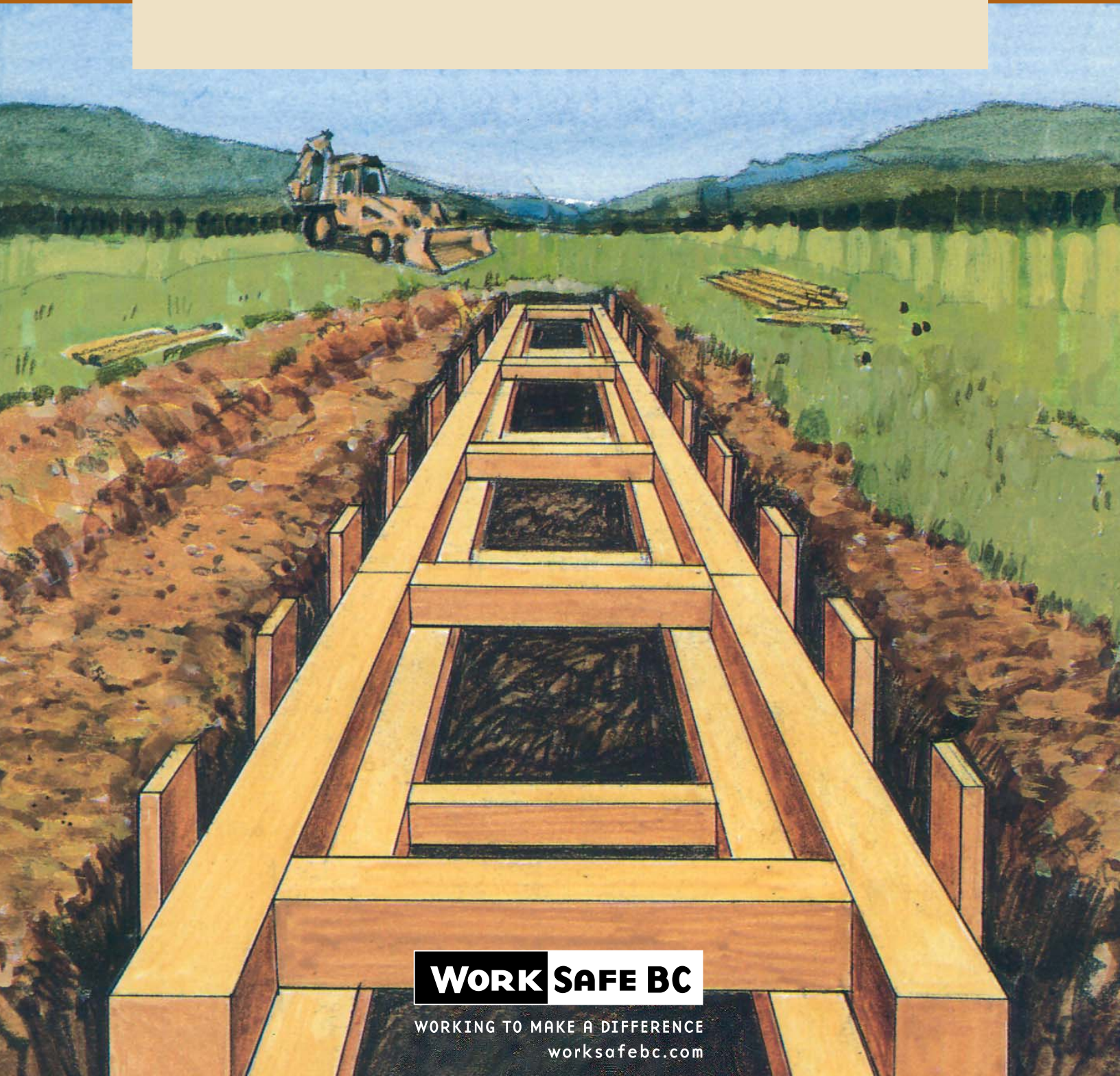


# SLOPING AND TIMBER SHORING



**WORK SAFE BC**

WORKING TO MAKE A DIFFERENCE  
[worksafebc.com](http://worksafebc.com)

WORKERS' COMPENSATION BOARD OF B.C.

## **About WorkSafeBC**

WorkSafeBC (the Workers' Compensation Board) is an independent provincial statutory agency governed by a Board of Directors. It is funded by insurance premiums paid by registered employers and by investment returns. In administering the *Workers Compensation Act*, WorkSafeBC remains separate and distinct from government; however, it is accountable to the public through government in its role of protecting and maintaining the overall well-being of the workers' compensation system.

WorkSafeBC was born out of a compromise between B.C.'s workers and employers in 1917 where workers gave up the right to sue their employers or fellow workers for injuries on the job in return for a no-fault insurance program fully paid for by employers. WorkSafeBC is committed to a safe and healthy workplace, and to providing return-to-work rehabilitation and legislated compensation benefits to workers injured as a result of their employment.

## **WorkSafeBC Prevention Information Line**

The WorkSafeBC Prevention Information Line can answer your questions about workplace health and safety, worker and employer responsibilities, and reporting a workplace accident or incident. The Prevention Information Line accepts anonymous calls.

Phone 604 276-3100 in the Lower Mainland, or call 1 888 621-7233 (621-SAFE) toll-free in British Columbia.

To report after-hours and weekend accidents and emergencies, call 604 273-7711 in the Lower Mainland, or call 1 866 922-4357 (WCB-HELP) toll-free in British Columbia.

# **SLOPING AND TIMBER SHORING**



WORKING TO MAKE A DIFFERENCE  
[worksafebc.com](http://worksafebc.com)

# WorkSafeBC Publications

---

Many publications are available on the WorkSafeBC web site. The Occupational Health and Safety Regulation and associated policies and guidelines, as well as excerpts and summaries of the *Workers Compensation Act*, are also available on the web site: <[www.worksafebc.com](http://www.worksafebc.com)>

Some publications are also available for purchase in print:

Phone: 604 232-9704  
Toll-free phone: 1 866 319-9704  
Fax: 604 232-9703  
Toll-free fax: 1 888 232-9714  
Online ordering: <[www.worksafebc.com](http://www.worksafebc.com)> and click on Publications;  
follow the links for ordering

© 2005 Workers' Compensation Board of British Columbia. All rights reserved. The Workers' Compensation Board of B.C. encourages the copying, reproduction, and distribution of this document to promote health and safety in the workplace, provided that the Workers' Compensation Board of B.C. is acknowledged. However, no part of this publication may be copied, reproduced, or distributed for profit or other commercial enterprise, nor may any part be incorporated into any other publication, without written permission of the Workers' Compensation Board of B.C.

## 2005 Edition

### **Library and Archives Canada Cataloguing in Publication Data**

Main entry under title:

Sloping and timber shoring. -- 2005 ed. -

Irregular.

"WorkSafe BC."

ISSN 1715-5053 = Sloping and timber shoring

1. Shoring and underpinning - Safety measures.
2. Earthwork - Safety measures. 3. Excavation - Safety measures. 4. Industrial safety - British Columbia.
- I. Workers' Compensation Board of British Columbia.

TA760.S54

624.1'52'00289

C2005-960165-5



# Contents

---

<b>Introduction</b> .....	ii	<b>End Shoring – Typical Detail</b> .....	10
<b>Pre-Excavation Requirements</b> .....	1	<b>Soft, Sandy, Filled, or Loose Soils With Plywood Sheathing (Type C)</b>	
		Depth 2.7 m (9 ft) Maximum .....	11
<b>Site Inspections</b> .....	2	<b>Position and Slope of Uprights</b> .....	11
<b>General Sloping or Shoring Requirements</b> .....	3	<b>Typical Blocking in Lieu of Backfilling</b> .....	12
<b>Size and Spacing of Members</b>		<b>Required Joint Arrangement for Walers</b> .....	12
Table 1 (Metric Units) .....	5	<b>Sequence for the Installation and Removal of Shoring</b> .....	12
Table 2 (Imperial Units) .....	6	<b>Required Slope of Unshored Excavation Walls</b> .....	13
<b>Hard and Solid Soils (Type A)</b>		<b>Benching</b> .....	13
Depth 1.2 m to 3 m (4 to 10 ft) .....	7	<b>Combined Sloping and Shoring</b> .....	13
Depth 3 m to 4.6 m (10 to 15 ft) .....	7	<b>Traffic Adjacent to Excavation</b> .....	14
Walers Omitted, Depth 1.2 m to 2.4 m (4 to 8 ft) .....	8		
<b>Soils Likely to Crack or Crumble (Type B)</b>		<b>WorkSafeBC Offices</b> .....	15
Depth 1.2 m to 3 m (4 to 10 ft) .....	8		
Depth 3 m to 4.6 m (10 to 15 ft) .....	9		
<b>Soft, Sandy, Filled, or Loose Soils (Type C)</b>			
Depth 1.2 m to 3 m (4 to 10 ft) .....	9		
Depth 3 m to 4.6 m (10 to 15 ft) .....	10		

# Introduction

---

This manual describes methods for sloping and timber shoring, including pre-excavation requirements, information on site inspections, and general sloping or shoring requirements.

Many people now use manufactured shoring; however, the scope of this book is limited to timber shoring.

# Pre-Excavation Requirements

---

1. Prior to the start of excavation with power tools and equipment, utility services in the area, such as electrical, gas, steam, water and sewer, must be located and any danger to workers removed or controlled.
2. Trees, utility poles, rocks, or similar objects near the area to be excavated must be removed or secured to ensure workers are not endangered.
3. Pointed tools must not be used for probing to locate underground gas or electrical facilities.
4. Excavations must be carried out in accordance with the written instructions of a professional engineer when or where any of the following conditions exist:
  - Excavations over 1.2 m (4 ft) deep with sides sloped at an angle steeper than  $\frac{3}{4}$  horizontal to 1 vertical
  - Excavations more than 6.1 m (20 ft) deep
  - Excavations adjacent to structures that apply loads to the soil in the excavated area
  - Excavations in soil subject to vibration or hydrostatic pressure likely to result in ground movement hazardous to workers
  - Excavations along natural or human-made side slopes that are steeper than 3 horizontal to 1 vertical
  - Excavations that are shored in a different fashion from those shown in the tables of Occupational Health and Safety Regulation
5. A certification of an excavation involves a design, specifications, and job site inspections at regular intervals by a professional engineer. The engineer is required to assume full responsibility for assessing the stability

of the soil for the duration of work being carried out inside, or in the vicinity of, the excavation. The engineer must propose design specifications which, based on professional judgment, provide a reasonable assurance that the excavation will remain stable.

The certification documents, duly signed by a professional engineer, must contain the following information:

- A description or drawing of the site or location for which the certification applies, with no need for verbal clarification
  - A drawing or description of excavation slope, depth, shoring, soil anchors, surface protection, drainage, etc. if applicable
  - Any limitations regarding the presence of heavy machinery permitted close to the top of the excavation
  - A geotechnical description of the soil conditions
  - A statement of professional opinion indicating the excavation is safe for work to be carried out inside or around the excavation
  - The date and time period for which the certification applies
  - The potential influence of changing weather conditions
  - The name of a designate person on the site authorized to determine changes in soil conditions, where applicable
6. Manufactured or prefabricated support systems including trench boxes and shoring cages must be designed and certified by a professional engineer. The certification must show how and for what soil types and depths the support system may be used and must be available at the site during use of the system.

## Site Inspections

---

In general, the engineer who certifies the excavation must inspect the site at intervals that allow him or her to recognize any change in soil conditions from the original assessment. The engineer must complete and sign an inspection report that describes any changing soil conditions and any action that needs to be taken.

The contractor must endeavour to carry out the excavation work accurately in accordance with the engineering drawings and specifications. Any deviations from the design must be promptly inspected by the engineer.

The engineer may designate an experienced person on the worksite to recognize changing soil conditions. The designated person reports any changes in soil conditions to the engineer. The engineer then assesses whether it is necessary to personally inspect the site again and issues an inspection report recording the observations and listing any required revisions to the original certification.



# General Sloping or Shoring Requirements

---

1. Minimum sloping or shoring requirements and maximum spacing of timbers are given in Tables 1 and 2 and illustrated in Figures 1 to 16. Variations from these standards or alternate designs must be in accordance with written instructions from a professional engineer.
2. When or where shoring is required, no worker shall be in an excavation until support systems are installed. Excavation support systems must be installed as soon as possible after excavation to minimize soil movement. The support system must be installed firmly in contact with the excavation walls. Any voids or spaces between the shoring system and the excavation walls must be backfilled or blocked, as shown in Figures 10 and 11. Shoring walers and struts should be installed starting near the top of the excavation, and progressing downward. Removal of these members should progress upward from the bottom of the trench.
3. Shoring uprights must extend at least 300 mm (1 ft) above the top of trench walls (except where road plates are being used). Uprights must go as close to the bottom of the trench as permitted by the material being installed in the trench, but in no case more than 600 mm (2 ft) from the bottom. Uprights must not be inclined outward more than 15° from vertical when viewed along the trench. (See Figure 10).
4. Sawn lumber used for shoring and timbering must be a minimum of No. 2 or better from the following groups:
  - Douglas fir-larch
  - Hemlock-fir
  - Spruce-pine-fir
  - Coast Sitka spruce
5. Hydraulic or pneumatic jacks must have a means to ensure they will not collapse.
6. A combination of sloping and shoring may be used, as shown in Figure 15.
7. Excavation slopes or supporting systems must be inspected daily or more frequently if required, and must be effectively maintained.
8. The sides of the excavation must be trimmed or scaled to remove any loose material, rocks, or other objects that could endanger workers.
9. A level area extending 600 mm (2 ft) back from the edges of the trench must be maintained free of materials and equipment.
10. In trenches or similar excavations over 1.2 m (4 ft) deep, a ladder or other safe means of entry and exit shall be provided in the immediate area where workers are employed. The ladder must extend from the bottom of the excavation to at least 1 m (3 ft) above the ground level.

Walkways for access to a bulk excavation must be at least 500 mm (20 in) wide, and have handrails and guardrails where required by the Occupational Health and Safety Regulation.
11. Water must not be allowed to accumulate and remain in excavations. Erosion of excavation faces or bearing surfaces must be controlled.

- 
12. End shoring may be omitted where the soil conditions at the end of the trench do not require shoring or where the maximum allowable spacing of uprights equals or exceeds the width of the trench. End shoring is required where the spacing of uprights must be close and tight or less than the trench width.

Where end shoring is required, the walers for the end shoring should be installed to bear against the walers that extend along each side of the trench, or alternately in a manner that will provide equivalent structural restraint.

End shoring must be designed by a professional engineer where the trench width exceeds 1.8 m (6 ft).

13. Where the base width of an excavation exceeds 3.7 m (12 ft), shoring may require engineering design or be impracticable. In an unsloped excavation that has not been certified by a professional engineer, workers should remain clear from the base of the slope a distance not less than the depth of the excavation. To ensure that workers do not violate this minimum distance, barricades, warning ribbons, and/or signage should be installed.

## Size and Spacing of Members

**Table 1: Trench Support Structures (Metric)**

Uprights			Walers		Struts/Cross Braces			
Trench depth (metres)	Minimum dimensions (millimetres)	Maximum spacing (metres)	Minimum dimensions (millimetres)	Maximum vertical spacing (metres)	Width of trench (metres)		Maximum spacing (metres)	
					Up to 1.8	1.8–3.7	Vertical	Horizontal
Minimum dimensions (millimetres)								
<b>Type A: Hard and solid soil</b>								
1.2–3 (Figure 1)	38 x 235	1.8	89 x 140	1.2	89 x 89	140 x 140	1.2	1.8
3–4.6 (Figure 2)	38 x 235	1.2	140 x 140	1.2	89 x 140	140 x 191	1.2	1.8
4.6–6	38 x 235	Close tight	140 x 140	1.2	140 x 191	191 x 191	1.2	1.8
<b>Type B: Soil likely to crack or crumble</b>								
1.2–3 (Figure 4)	38 x 235	1.2	89 x 140	1.2	89 x 140	140 x 140	1.2	1.8
3–4.6 (Figure 5)	38 x 235	0.9	140 x 191	1.2	140 x 140	140 x 191	1.2	1.8
4.6–6	38 x 235	Close tight	140 x 191	1.2	140 x 191	191 x 191	1.2	1.8
<b>Type C: Soft, sandy, filled, or loose soil</b>								
1.2–3 (Figure 6)	38 x 235	Close tight	140 x 191	1.2	140 x 140	140 x 191	1.2	1.8
3–4.6 (Figure 7)	38 x 235	Close tight	191 x 191	1.2	140 x 191	191 x 191	1.2	1.8
4.6–6	64 x 235	Close tight	191 x 241	1.2	140 x 191	191 x 241	1.2	1.8

### Notes:

- The dimensions shown are minimum and must be increased if necessary to meet job conditions.
- The dimensions of members in millimetres are actual dimensions for surfaced dry materials. The dimensions in inches are the nominal values for surfaced dry materials. Members must be at least No. 2 or better, Douglas Fir-Larch, Hemlock-Fir, Spruce-Pine-Fir, or Coast Sitka Spruce.
- Trenches less than 1.2 m (4 ft) deep must be shored when the potential for hazardous ground movement is likely, as in ground subject to hydrostatic pressure or vibration.
- Walers may be omitted in trenches not exceeding 2.4 m (8 ft) in depth provided the soil is sufficiently hard and solid to safely permit waler deflection, and the trench is not in proximity to previously excavated ground.
- At least two struts must be installed in each vertical plane where struts are required.
- For trenches 4.6 to 6.1 m (15 to 20 ft) deep, shoring for each soil type should be similar in general appearance to that shown in Figure 7.

## Size and Spacing of Members *(continued)*

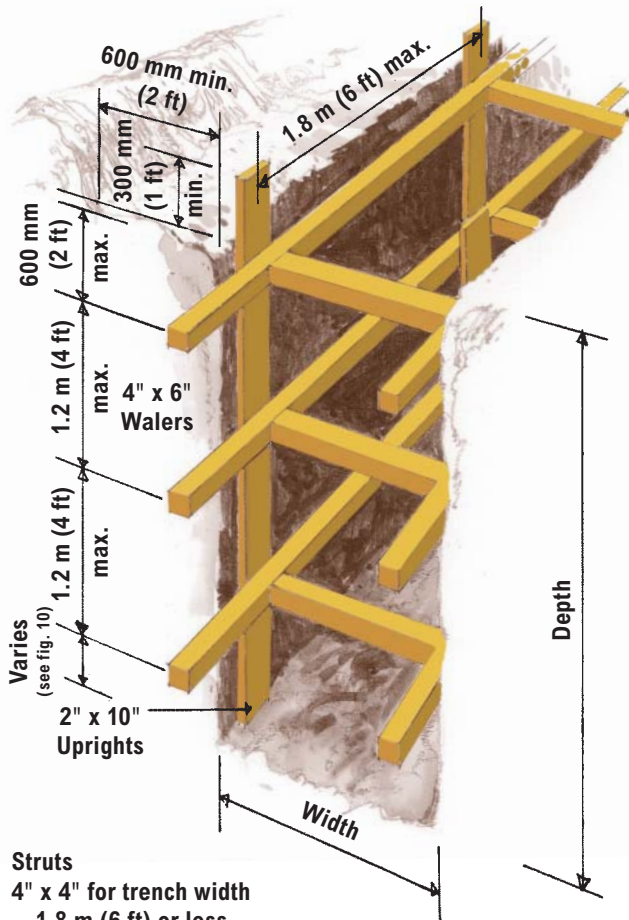
**Table 2: Trench Support Structures (Imperial)**

Uprights			Walers		Struts/Cross Braces			
Trench depth (feet)	Minimum dimensions (inches)	Maximum spacing (feet)	Minimum dimensions (inches)	Maximum vertical spacing (feet)	Width of trench (feet)		Maximum spacing (feet)	
					Up to 6	6–12	Vertical	Horizontal
					Minimum dimensions (inches)			
<b>Type A: Hard and solid soil</b>								
4–10 (Figure 1)	2 x 10	6	4 x 6	4	4 x 4	6 x 6	4	6
10–15 (Figure 2)	2 x 10	4	6 x 6	4	4 x 6	6 x 8	4	6
15–20	2 x 10	Close tight	6 x 6	4	6 x 8	8 x 8	4	6
<b>Type B: Soil likely to crack or crumble</b>								
4–10 (Figure 4)	2 x 10	4	4 x 6	4	4 x 6	6 x 6	4	6
10–15 (Figure 5)	2 x 10	3	6 x 8	4	6 x 6	6 x 8	4	6
15–20	2 x 10	Close tight	6 x 8	4	6 x 8	8 x 8	4	6
<b>Type C: Soft, sandy, filled, or loose soil</b>								
4–10 (Figure 6)	2 x 10	Close tight	6 x 8	4	6 x 6	6 x 8	4	6
10–15 (Figure 7)	2 x 10	Close tight	8 x 8	4	6 x 8	8 x 8	4	6
15–20	3 x 10	Close tight	8 x 10	4	6 x 8	8 x 10	4	6

Notes on Table 1 apply to Table 2.

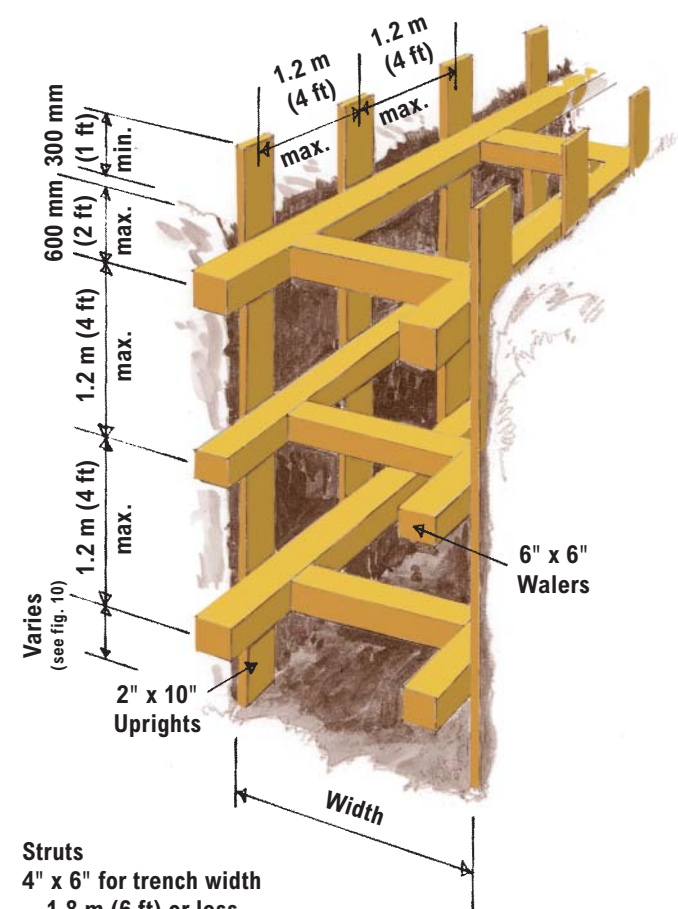
## Hard and Solid Soils (Type A)

Figure 1: Depth 1.2 m to 3 m (4 to 10 ft)



**Struts**  
 4" x 4" for trench width  
 1.8 m (6 ft) or less  
 6" x 6" for trench width  
 1.8 m to 3.7 m  
 (6 ft to 12 ft)

Figure 2: Depth 3 m to 4.6 m (10 to 15 ft)



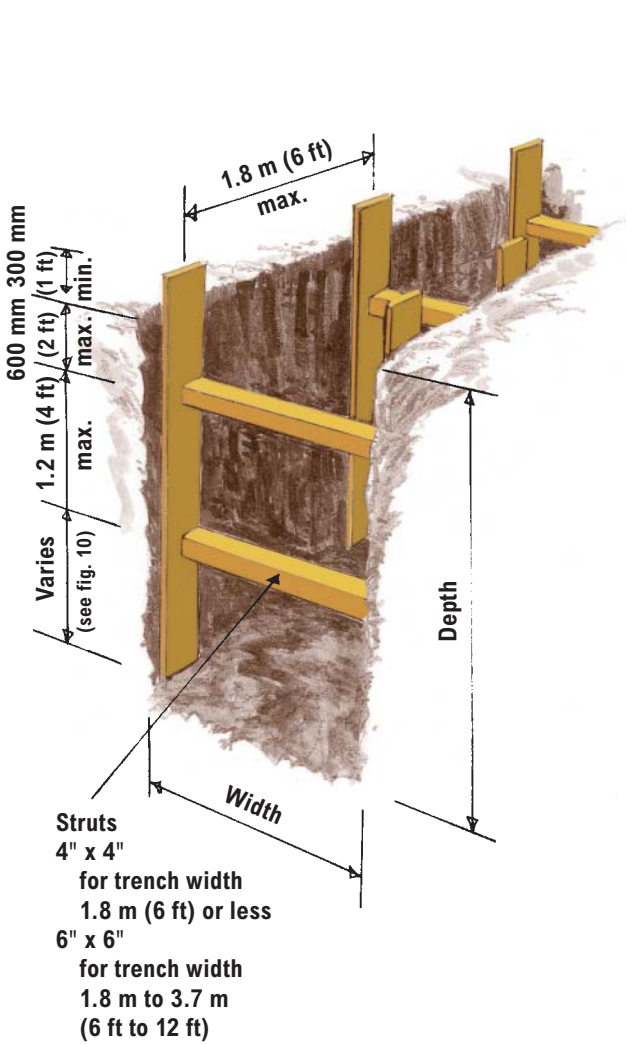
**Struts**  
 4" x 6" for trench width  
 1.8 m (6 ft) or less  
 6" x 8" for trench width  
 1.8 m to 3.7 m  
 (6 ft to 12 ft)

**Note:** For trenches 4.6 m to 6.1 m (15 to 20 ft) deep, refer to Table 1 or 2 for size and spacing of members. The general appearance is shown in Figure 6 or 7, except that additional walers and struts will be required.



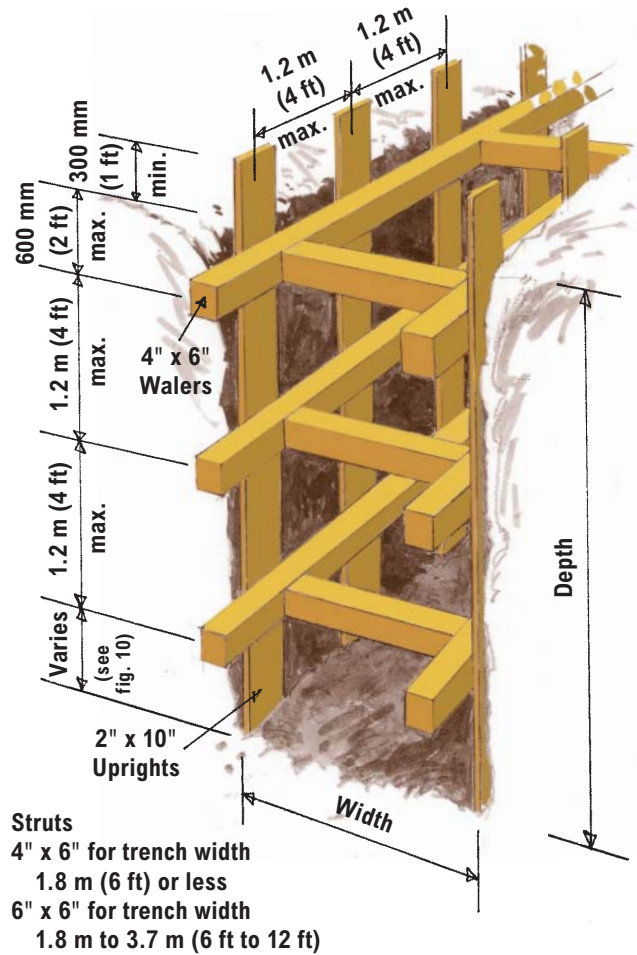
**Hard and Solid Soils (Type A)**  
(continued)

**Figure 3: With Walers Omitted**  
Depth 1.2 m to 2.4 m (4 to 8 ft)



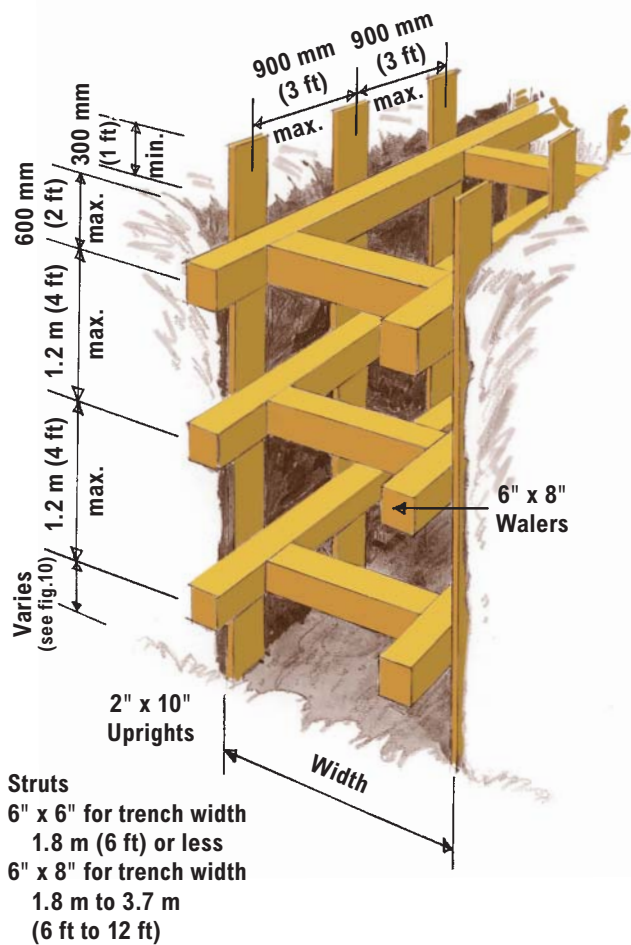
**Soils Likely to Crack or Crumble (Type B)**

**Figure 4: Depth 1.2 m to 3 m (4 to 10 ft)**



**Soils Likely to Crack or Crumble (Type B) (continued)**

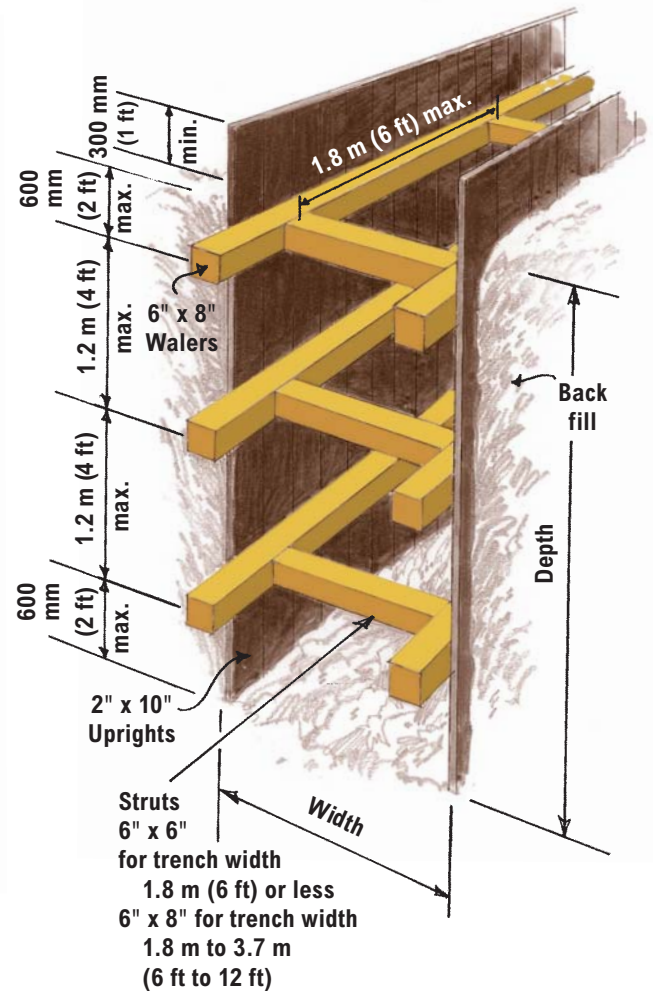
**Figure 5: Depth 3 m to 4.6 m (10 to 15 ft)**



**Note:** For trenches 4.6 m to 6.1 m (15 to 20 ft) deep, refer to Table 1 or 2 for size and spacing of members. The general appearance is shown in Figure 6 or 7, except that additional walers and struts will be required.

**Soft, Sandy, Filled, or Loose Soils (Type C)**

**Figure 6: Depth 1.2 m to 3 m (4 to 10 ft)**

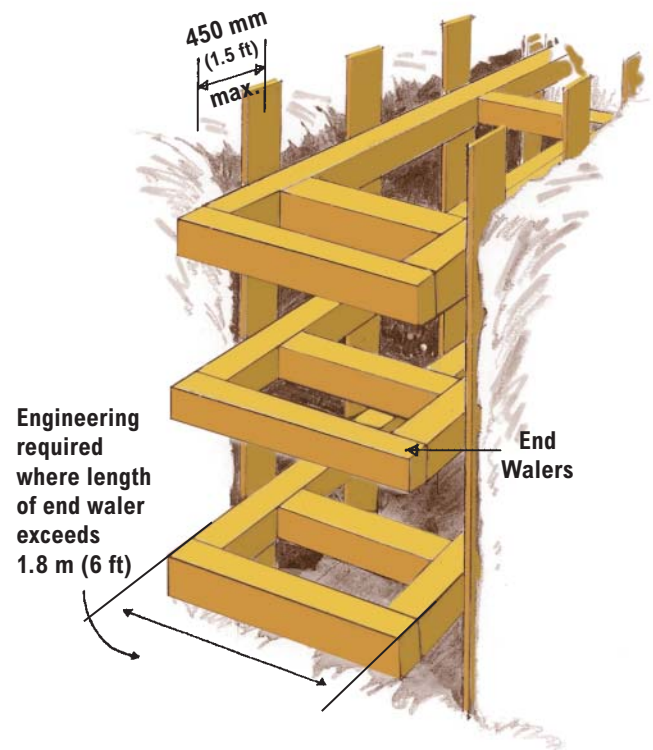
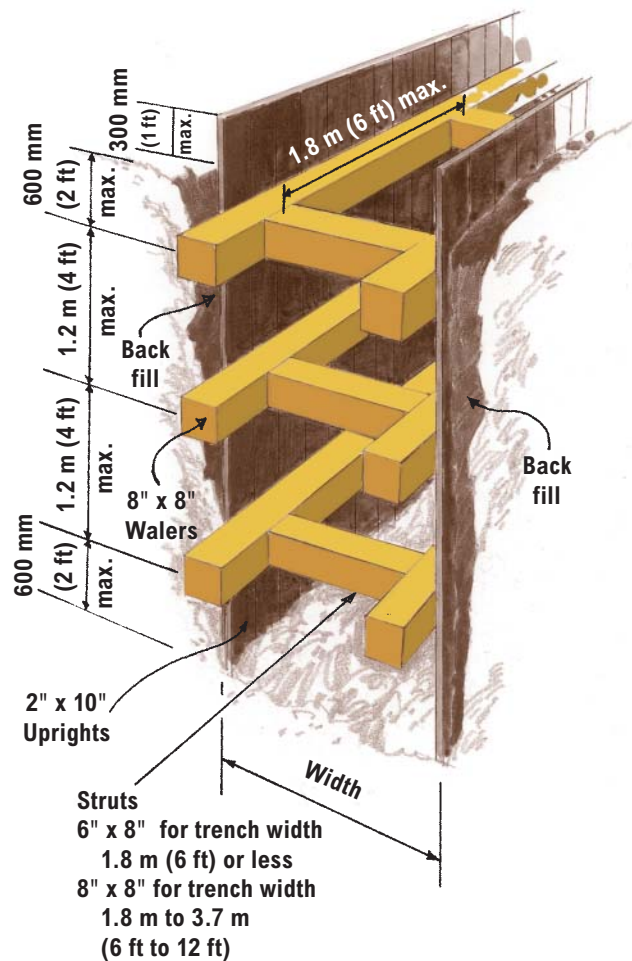


**Note:** The third level of bracing is optional, depending on the depth of excavation.

**Soft, Sandy, Filled, or Loose Soils  
(Type C) (continued)**

**Figure 8  
End Shoring — Typical Detail**

**Figure 7: Depth 3 m to 4.6 m (10 to 15 ft)**



**Note:** For trenches 4.6 m to 6.1 m (15 to 20 ft) deep, refer to Table 1 or 2 for size and spacing of members. The general appearance is shown in Figure 6 or 7, except that additional walers and struts will be required. Uprights must extend to bottom of trench.

Uprights for end shoring are not shown for clarity.

Refer to Table 1 or 2 for appropriate size and spacing of uprights and walers.

Soil type at end of trench may be different than at sides of trench. Walers and uprights installed for end shoring must be appropriate for local soil type.

## Soft, Sand, Filled, or Loose Soils With Plywood Sheathing (Type C)

Figure 9: Depth 2.7 m (9 ft) Maximum

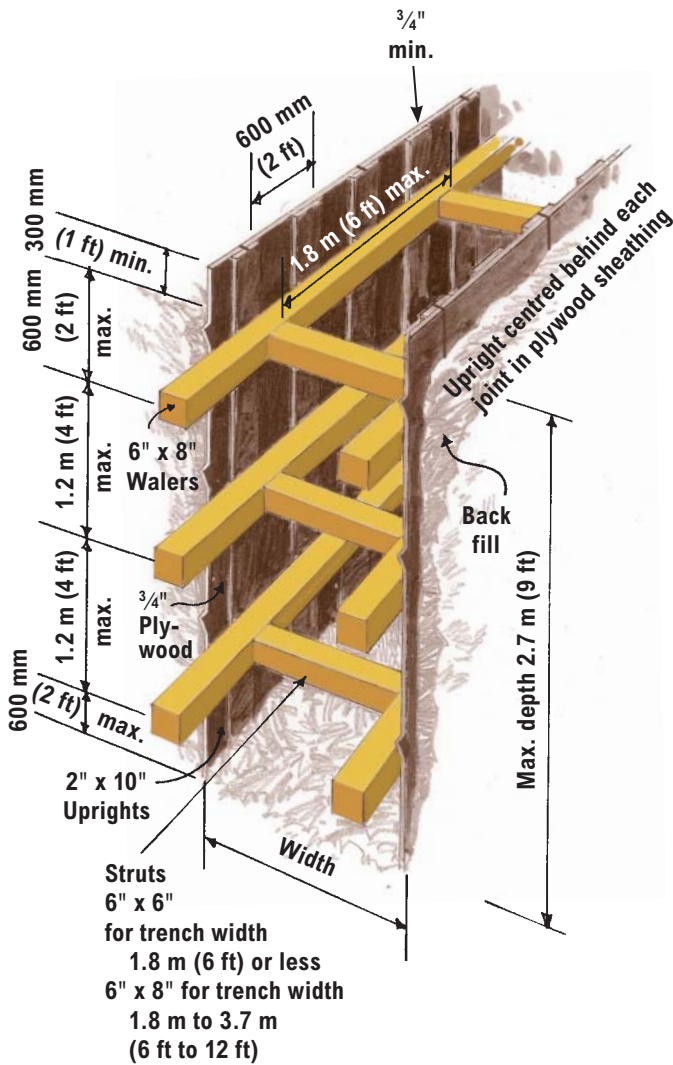
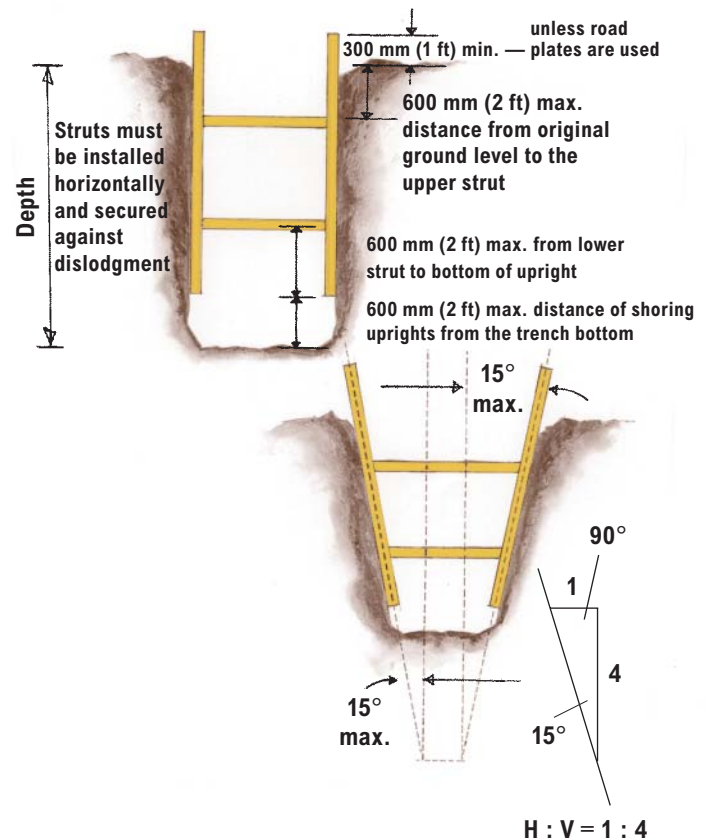


Figure 10  
Position and Slope of Uprights



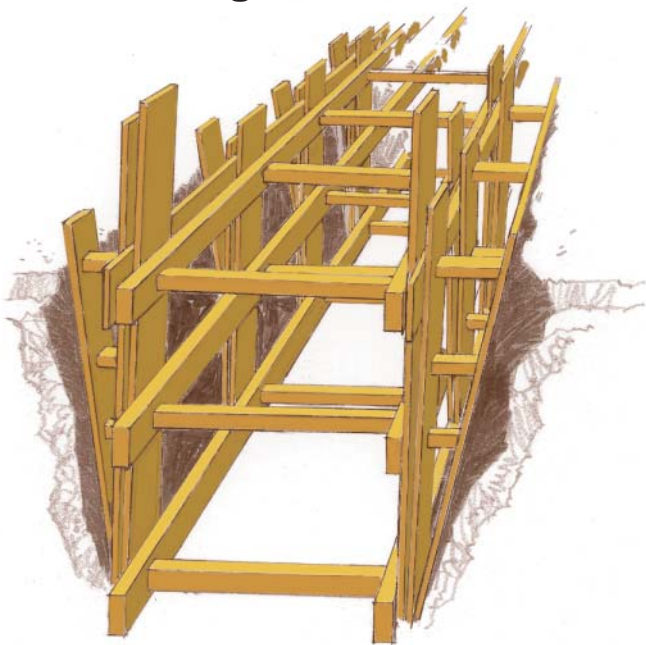
### Notes:

Shoring must be sized for the full depth of the trench.

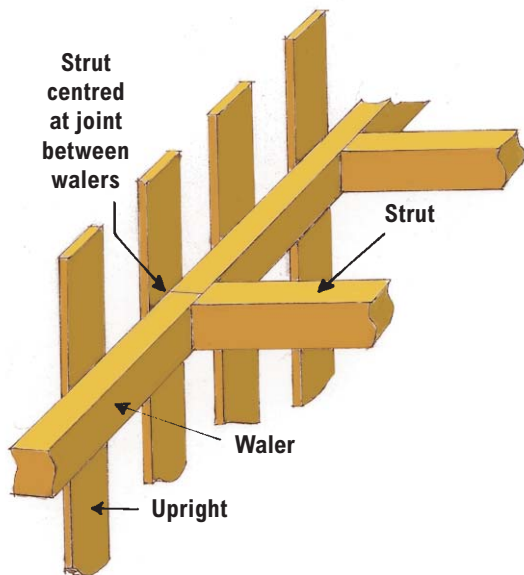
There should be no indication while the trench is open of a possible loss of soil from behind or below the bottom of the shoring. Generally, the stability of Type C soils (soft, sandy, filled, or loose) will not be adequate to permit significant excavation below the shoring.



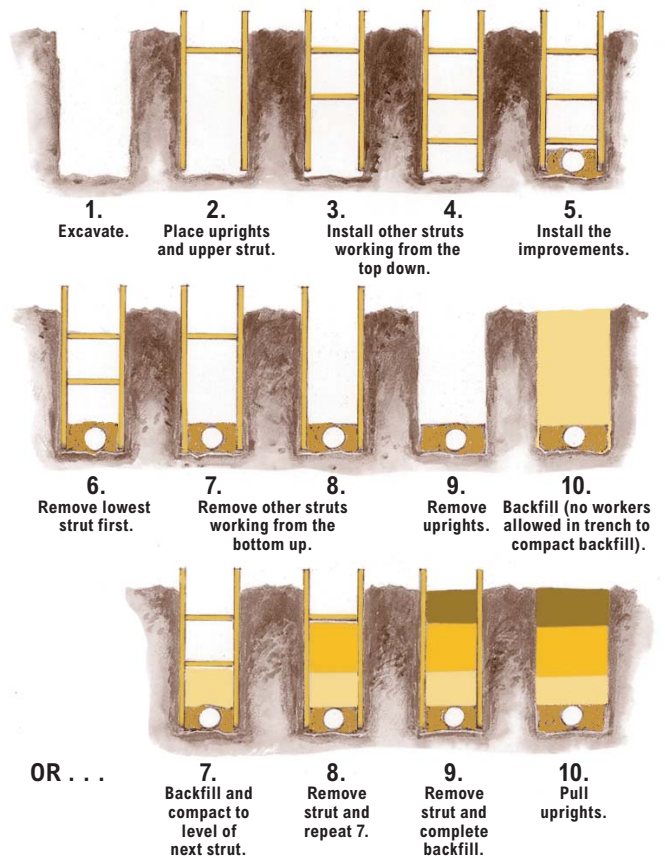
**Figure 11**  
**Typical Blocking in Lieu**  
**of Backfilling**



**Figure 12**  
**Required Joint Arrangement**  
**for Walers**

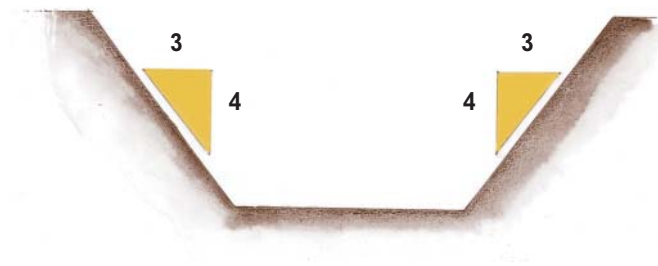


**Figure 13**  
**Sequence for the Installation**  
**and Removal of Shoring**





**Figure 14**  
**Required Slope of Unshored**  
**Excavation Walls**

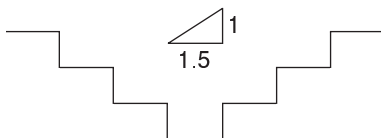


Unshored trench and excavation walls must be sloped flatter than the angle of repose, but in no case steeper than 3 horizontal to 4 vertical unless otherwise specified in writing by a professional engineer.

The angle of repose is the natural stable slope loose excavated material forms when dumped on a level surface.

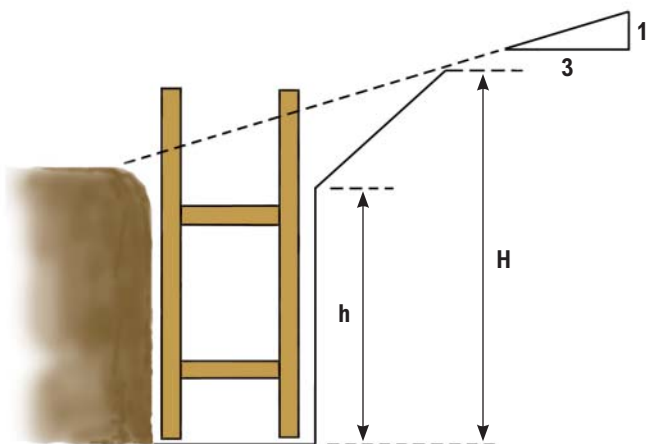
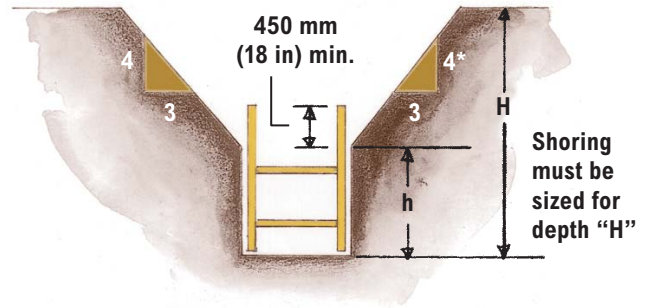
**Benching**

All benched excavations 6.1 m (20 ft) or less in depth shall have a maximum rise between benches of 1.2 m (4 ft). For unrestricted worker access at any level, the width of the bench immediately above any particular rise shall not be less than 1.5 times the height of that rise. For example, the minimum bench width for a 1.2 m (4-ft) rise would be 1.8 m (6 ft).



↑	1.2 m (4 ft)
↓	Maximum
↑	1.2 m (4 ft)
↓	Maximum
↑	1.2 m (4 ft)
↓	Maximum

**Figure 15**  
**Combined Sloping and Shoring**



Where side slope of original ground is steeper than 3H:1V, soil pressures are greater and engineering is required.



## WorkSafeBC Offices

---

Visit our web site at <[www.worksafebc.com](http://www.worksafebc.com)>.

### **Abbotsford**

2774 Trethewey Street V2T 3R1  
Phone 604 276-3100  
1 800 292-2219  
Fax 604 556-2077

### **Burnaby**

450 – 6450 Roberts Street V5G 4E1  
Phone 604 276-3100  
1 888 621-7233  
Fax 604 232-5950

### **Coquitlam**

104 – 3020 Lincoln Avenue V3B 6B4  
Phone 604 276-3100  
1 888 967-5377  
Fax 604 232-1946

### **Courtenay**

801 30th Street V9N 8G6  
Phone 250 334-8765  
1 800 663-7921  
Fax 250 334-8757

### **Kamloops**

321 Battle Street V2C 6P1  
Phone 250 371-6003  
1 800 663-3935  
Fax 250 371-6031

### **Kelowna**

110 – 2045 Enterprise Way V1Y 9T5  
Phone 250 717-4313  
1 888 922-4466  
Fax 250 717-4380

### **Nanaimo**

4980 Wills Road V9T 6C6  
Phone 250 751-8040  
1 800 663-7382  
Fax 250 751-8046

### **Nelson**

524 Kootenay Street V1L 6B4  
Phone 250 352-2824  
1 800 663-4962  
Fax 250 352-1816

### **North Vancouver**

400 – 224 Esplanade Ave. W. V7M 1A4  
Phone 604 276-3100  
1 888 875-6999  
Fax 604 232-1558

### **Prince George**

1066 Vancouver Street V2L 5M4  
Phone 250 561-3700  
1 800 663-6623  
Fax 250 561-3710

### **Surrey**

100 – 5500 152 Street V3S 5J9  
Phone 604 276-3100  
1 888 621-7233  
Fax 604 232-7077

### **Terrace**

4450 Lakelse Avenue V8G 1P2  
Phone 250 615-6605  
1 800 663-3871  
Fax 250 615-6633

### **Victoria**

4514 Chatterton Way V8X 5H2  
Phone 250 881-3418  
1 800 663-7593  
Fax 250 881-3482

### **Head Office / Richmond**

*Prevention Information Line:*  
Phone 604 276-3100  
1 888 621-7233 (621-SAFE)

*Administration:*

6951 Westminster Highway  
Phone 604 273-2266

*Mailing Address:*

PO Box 5350 Stn Terminal  
Vancouver BC V6B 5L5

### **After Hours**

**Health & Safety Emergency**  
604 273-7711  
1 866 922-4357 (WCB-HELP)

R06/05

